

BASCULANTE DL 102 & DL 102 CADRE NU

NOTICE TECHNIQUE

(cotes en mm)

Coupes verticales

POSE EN APPLIQUE

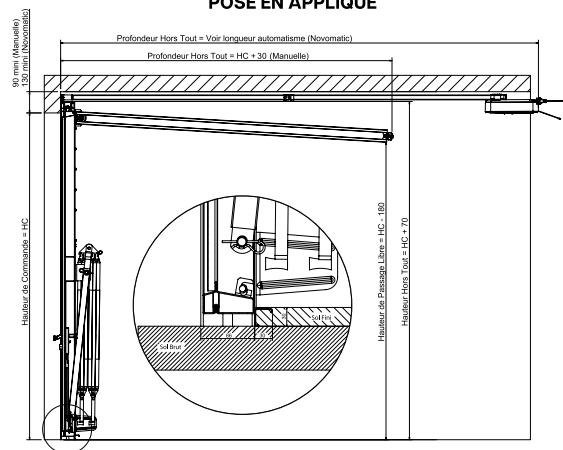

POSE EN TUNNEL

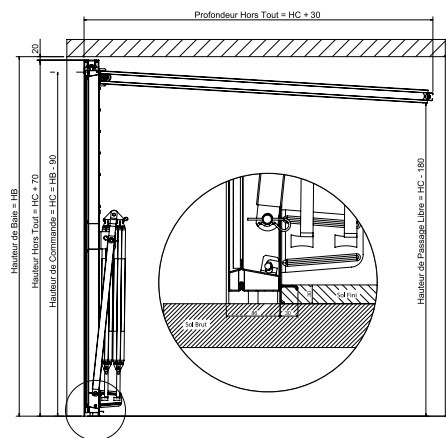

Coupes horizontales

POSE EN APPLIQUE

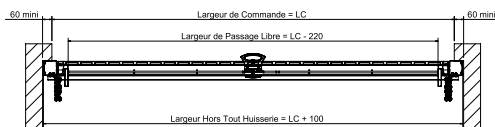

POSE EN TUNNEL

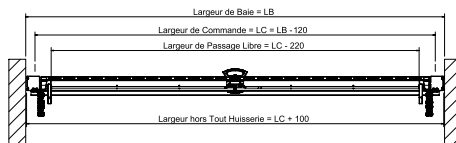

BASCULANTE DL 102 & DL 102 CADRE NU

SCHÉMAS TECHNIQUES

(cotes en mm)

Emprise au sol

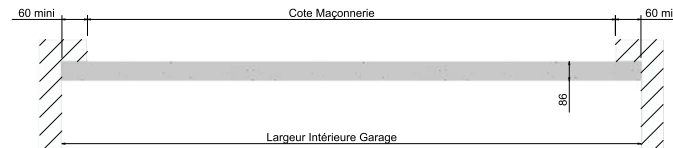

Cadre nu parement vertical remplissage standard

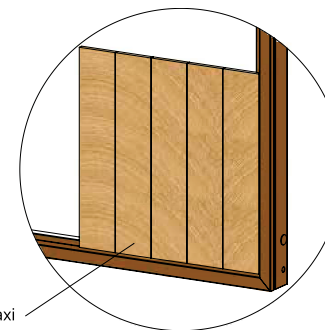
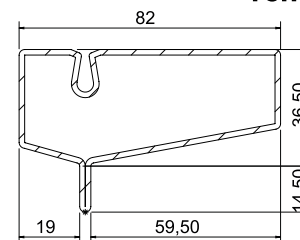

Cadre nu parement vertical remplissage en applique

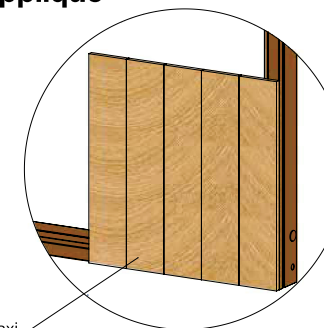
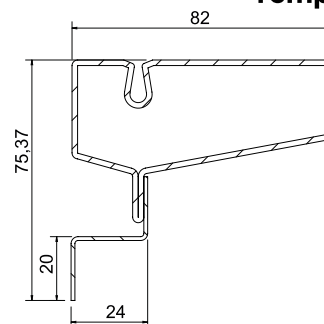

Tous nos plans de détails en téléchargement sur notre site internet.